

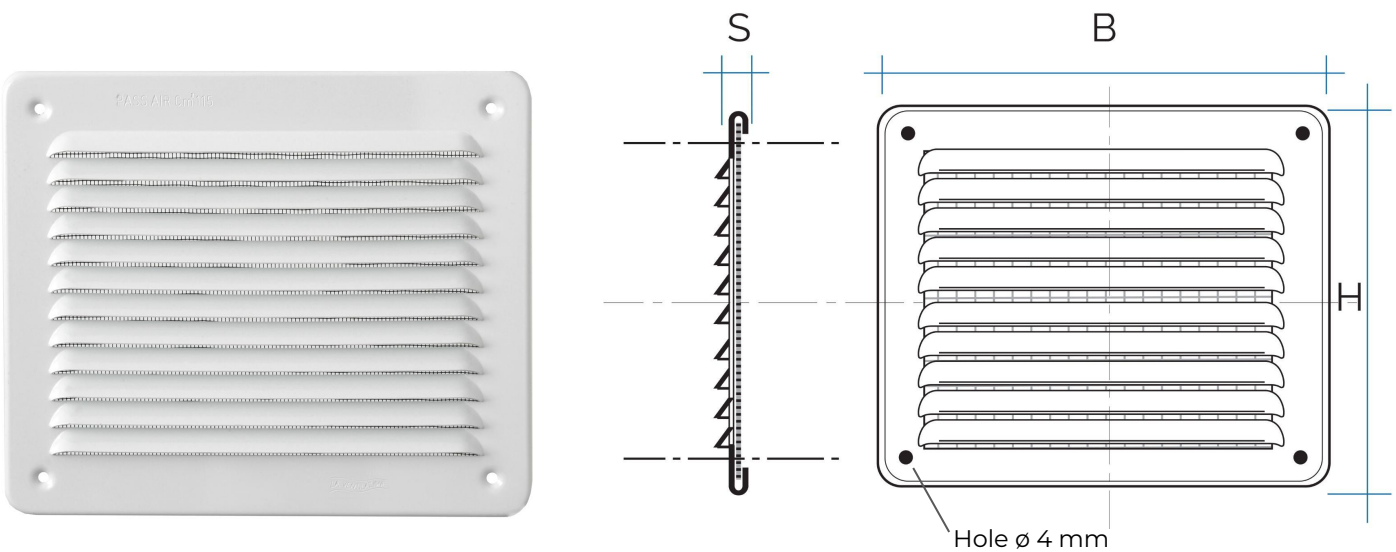





Surface-mounted metal grilles to screw



 = Compatible with saline environments

	Item	Colour	BxH mm	S mm	Pass Air cm ²	Insect screen
	LB1916ZK	aluzink	193x165	8	125	
	LBR1916ZK	aluzink	193x165	8	115	✓
	LBR1916RA	copper	193x165	8	115	✓
	LBR1916IN	inox 430	193x165	8	115	✓
	LBR1916AR	copper effect	193x165	8	115	✓
	LBR1916AB	white alu.	193x165	8	115	✓

Description: Surface-mounted rectangular ventilation grille

Material: Metal



Features: Rectangular metal ventilation grille, to be surface mounted with screws and plugs. Distance between holes 165x137 mm. It can be installed both indoors and outdoors.

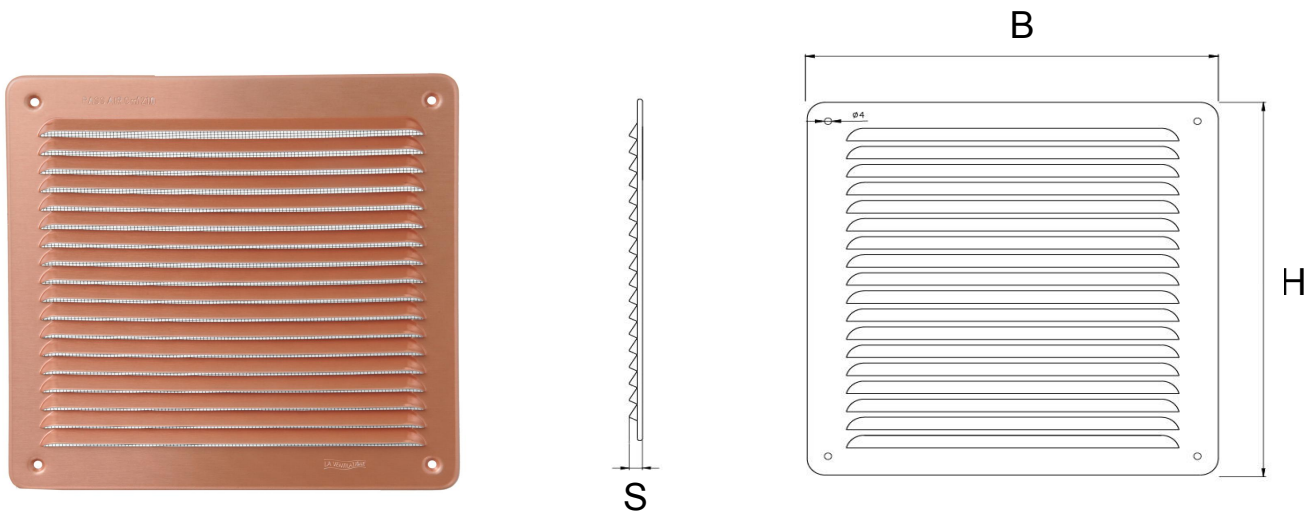

Surface-mounted metal grilles to screw



 = Compatible with saline environments

	Item	Colour	BxH mm	S mm	Pass Air cm ²	Insect screen
	LAR2323ZK	aluzink	228x228	8	210	
	LAR2323RA	copper	228x228	8	210	✓
	LAR2323IN	inox 430	228x228	8	210	✓
	LAR2323AR	copper effect	228x228	8	210	✓
	LAR2323AB	white alu.	228x228	8	210	✓

Description: Surface-mounted rectangular ventilation grille

Material: Metal

Features: Rectangular metal ventilation grille, to be surface mounted with screws and plugs. Distance between holes 195x195 mm. It can be installed both indoors and outdoors.

