

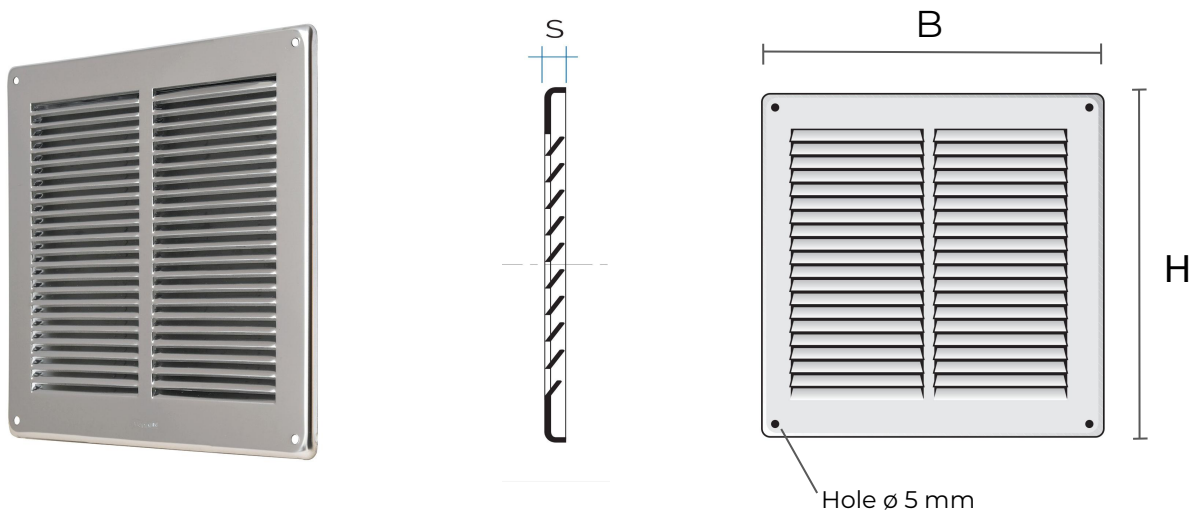

Surface-mounted metal grilles to screw



 = Compatible with saline environments

Item	Colour	BxH mm	S mm	Pass Air cm ²
GL24B	white	240x240	5	170
GL24M	brown	240x240	5	170
GL24G	grey	240x240	5	170
GL24N	black	240x240	5	170
GIN24	inox 430	240x240	5	170
GRA24	copper	240x240	5	170
 GAL24	silver alu.	240x240	5	170
 GZK24	aluzink	240x240	5	170

Description: Surface-mounted square ventilation grille

Material: Metal



Features: Square metal ventilation grille, to be surface mounted with screws and plugs. Distance between holes 218x218 mm. It can be installed both indoors and outdoors.

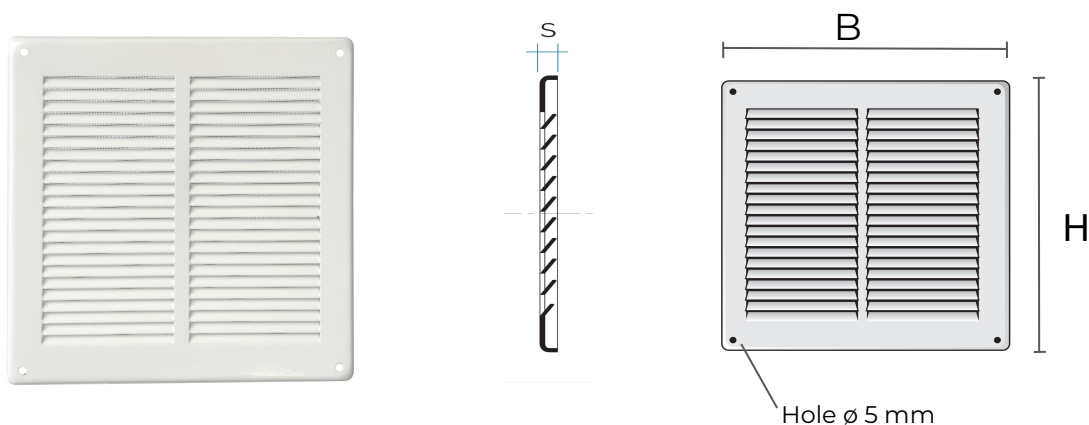

Surface-mounted metal grilles to screw



 = Compatible with saline environments

Item	Colour	BxH mm	S mm	Pass Air cm ²	Insect screen
GL24RB	white	240x240	5	170	✓
GL24RM	brown	240x240	5	170	✓
GL24RG	grey	240x240	5	170	✓
GL24RN	black	240x240	5	170	✓
GIN24R	inox 430	240x240	5	170	✓
GRA24R	copper	240x240	5	170	✓
 GAL24R	silver alu.	240x240	5	170	✓
 GZK24R	aluzink	240x240	5	170	✓
 GAL24RB	white alu.	240x240	5	170	✓

Description: Surface-mounted square ventilation grille

Material: Metal

Features: Square metal ventilation grille, to be surface mounted with screws and plugs, including insect screen. Distance between holes 218x218 mm. It can be installed both indoors and outdoors.

