

Kit Garage 130

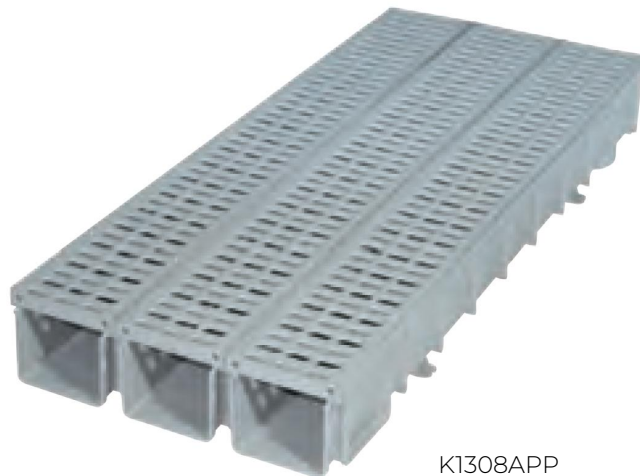

K1308APP

Item
K1308APP

The item **K1308APP** is composed of the following products:

- n. 3 = CSA130PP
- n. 3 = SGN130PP
- n. 2 = TCA13080PP

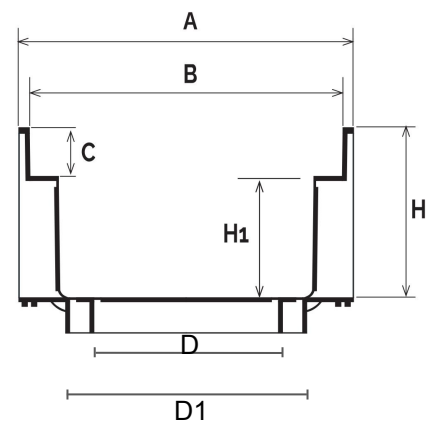
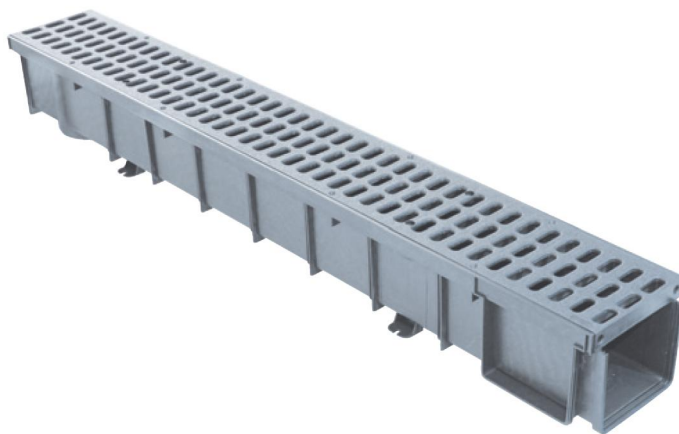

Item	A mm	B mm	C mm	D mm	D1 mm	H mm	H1 mm	L mm
CSA130PP	138	130	20	80M-100M	75M-110M	110	90	1000

Classe di carico **A15**



SGN130PP

Passaggio acqua cm² 385

SEZIONE GRIGLIA

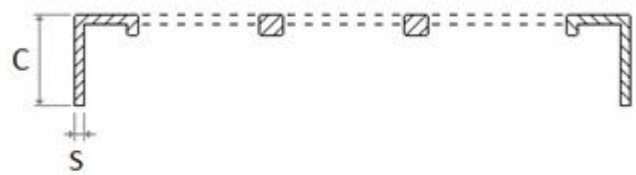

ASOLA

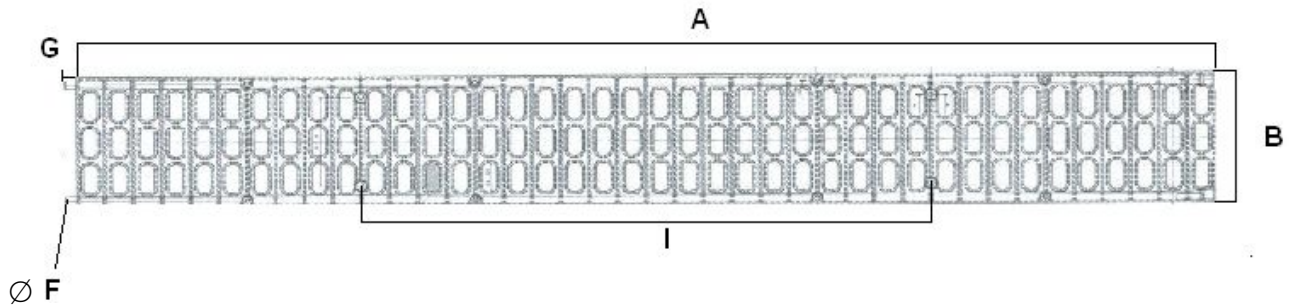
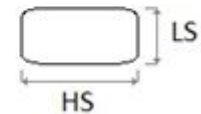

Codice	A mm	B mm	C mm	HS mm	LS mm	F Ø mm	G mm	I mm	S mm	Peso g
SGN130PP	1000	129	20	28	12	7,6	10	500	2,1	610



TCA13080PP

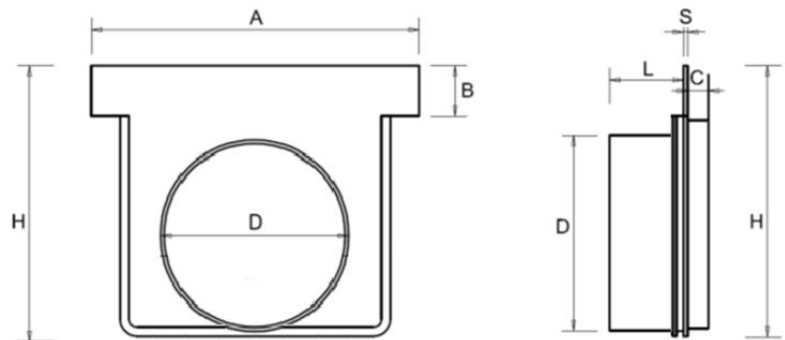

Item	A mm	B mm	C mm	D mm	H mm	L mm	S mm	Weight g
TCA13080PP	138	22	8	80-80,3	114	25	1,7	54

Material:

CSA130PP "Polypropylene" - SGN130PP "Polypropylene" - TCA13080PP "Polypropylene"

Features:

The channels allow you to solve all rainwater drainage problems within car parks, courtyards, yards and garages.

