

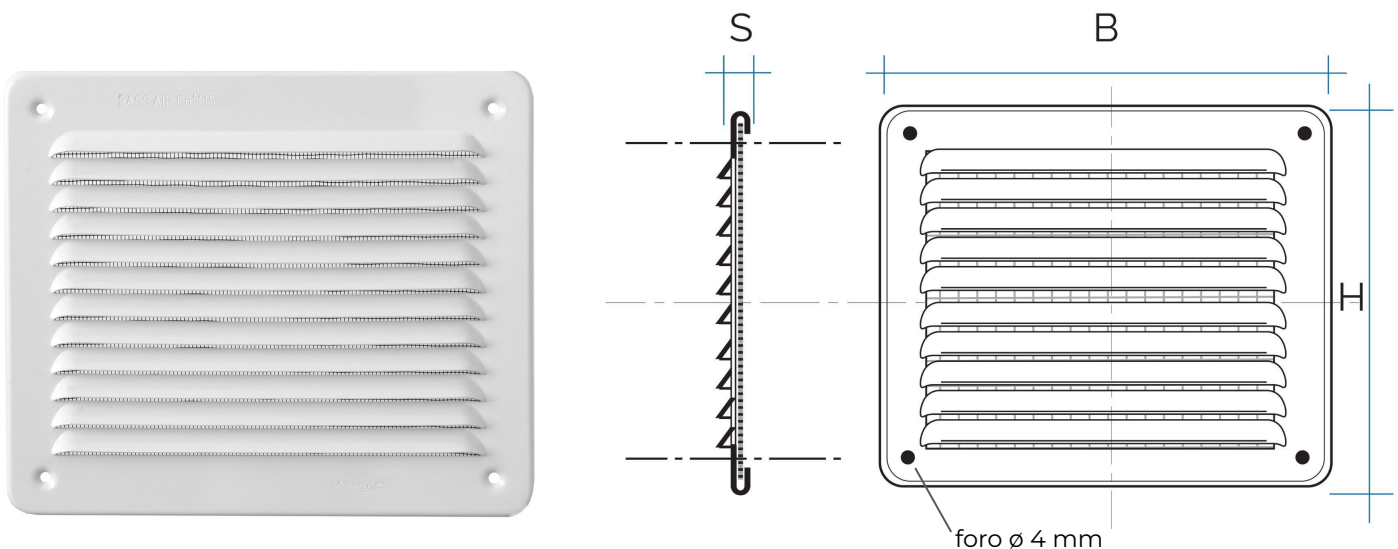





Griglie in metallo universali da sovrapporre



 = Griglia idonea per ambienti salini

	Codice	Colore	BxH mm	S mm	Pass Air cm ²	Rete antinsetti
	LB1916ZK	aluzink	193x165	8	125	
	LBR1916ZK	aluzink	193x165	8	115	✓
	LBR1916RA	rame	193x165	8	115	✓
	LBR1916IN	inox 430	193x165	8	115	✓
	LBR1916AR	allu. ramato	193x165	8	115	✓
	LBR1916AB	allu. bianco	193x165	8	115	✓

Descrizione: Griglia di ventilazione rettangolare da sovrapporre

Materiale: Metallo



Caratteristiche: Griglia di ventilazione rettangolare in metallo, da sovrapporre con viti e tasselli. Interasse tra i fori 165x137 mm. Può essere installata sia per ambienti interni sia esterni.

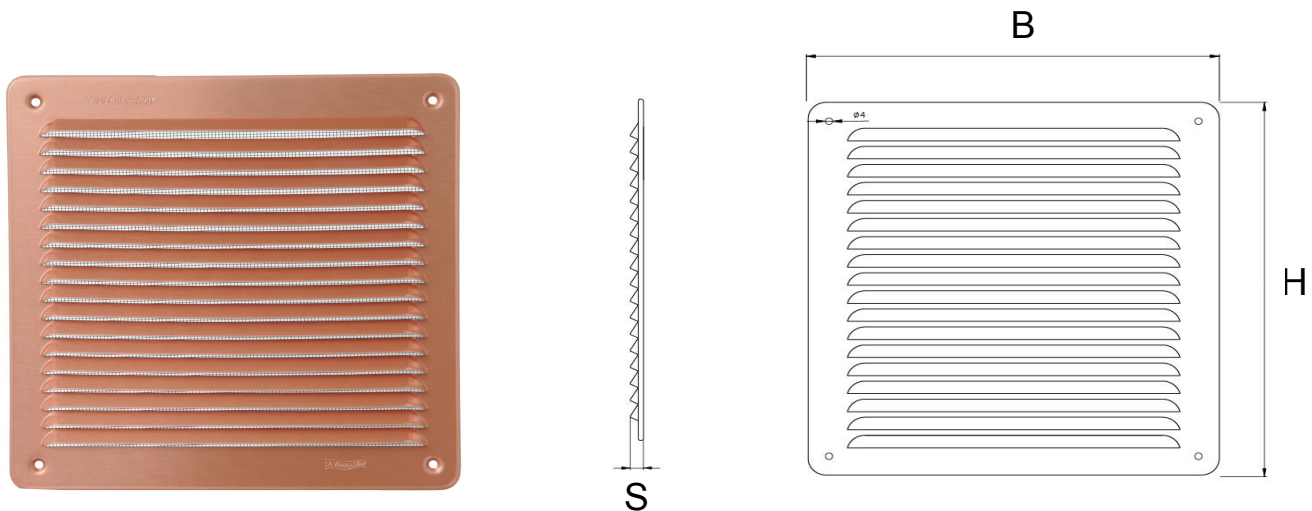

Griglie in metallo universali da sovrapporre



 = Griglia idonea per ambienti salini

	Codice	Colore	BxH mm	S mm	Pass Air cm ²	Rete antinsetti
	LAR2323ZK	aluzink	228x228	8	210	
	LAR2323RA	rame	228x228	8	210	✓
	LAR2323IN	inox 430	228x228	8	210	✓
	LAR2323AR	allu. ramato	228x228	8	210	✓
	LAR2323AB	allu. bianco	228x228	8	210	✓

Descrizione: Griglia di ventilazione rettangolare da sovrapporre

Materiale: Metallo

Caratteristiche: Griglia di ventilazione rettangolare in metallo, da sovrapporre con viti e tasselli. Interasse tra i fori 195x195 mm. Può essere installata sia per ambienti interni sia esterni.

