

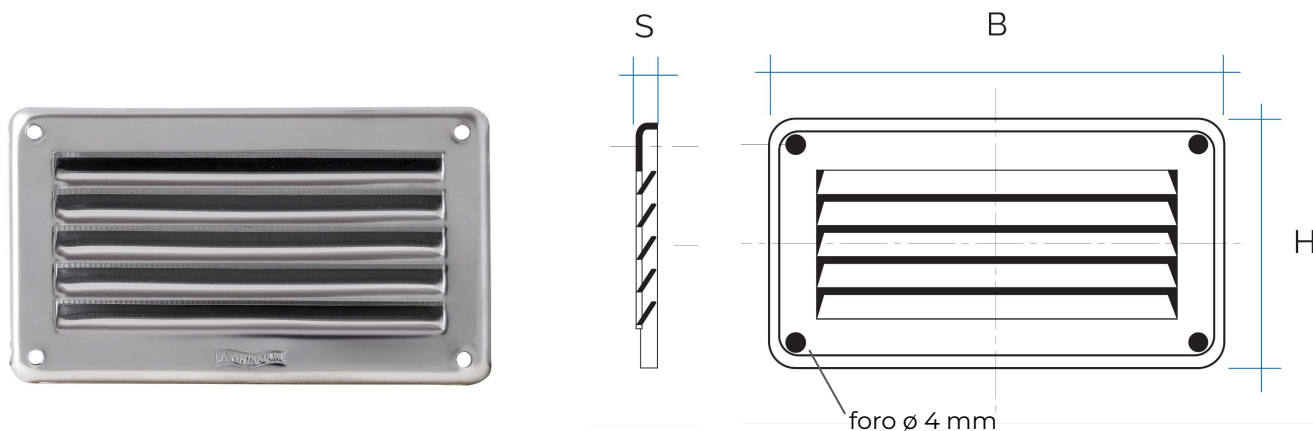

Griglie in metallo da sovrapporre



 = Griglia idonea per ambienti salini

Codice	Colore	BxH mm	S mm	Pass Air cm ²
GL106B	bianco	100x60	5	20
GL106M	marrone	100x60	5	20
GL106G	grigio	100x60	5	20
GL106N	nero	100x60	5	20
GIN106	inox 430	100x60	5	20
GRA106	rame	100x60	5	20
 GAL106	allu. argento	100x60	5	20

Descrizione: Griglia di ventilazione rettangolare da sovrapporre

Materiale: Metallo

Caratteristiche: Griglia di ventilazione rettangolare in metallo, da sovrapporre con viti e tasselli. Interasse tra i fori 90x50 mm. Può essere installata sia per ambienti interni sia esterni.



Griglie in metallo da sovrapporre

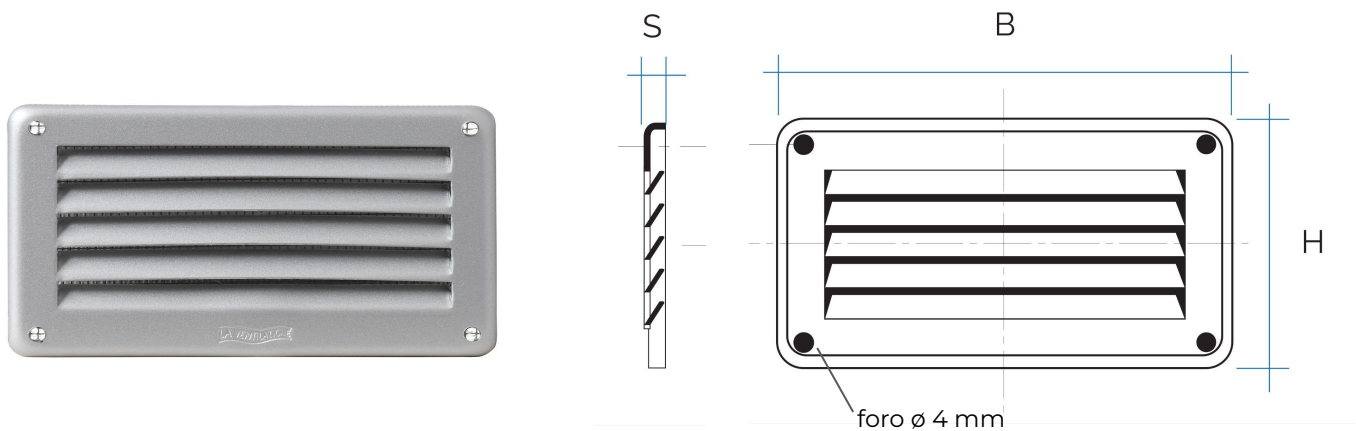

 = Griglia idonea per ambienti salini

Codice	Colore	BxH mm	S mm	Pass Air cm ²	Rete antinsetti
GL106RB	bianco	100x60	5	20	✓
GL106RM	marrone	100x60	5	20	✓
GL106RG	grigio	100x60	5	20	✓
GL106RN	nero	100x60	5	20	✓
GIN106R	inox 430	100x60	5	20	✓
GRA106R	rame	100x60	5	20	✓
 GAL106R	allu. argento	100x60	5	20	✓

Descrizione: Griglia di ventilazione rettangolare da sovrapporre

Materiale: Metallo

Caratteristiche: Griglia di ventilazione rettangolare in metallo, da sovrapporre, completa di rete antinsetti. Interasse tra i fori 90x50 mm. Può essere installata sia per ambienti interni sia esterni.

