

## Giunto assemblato per canale di gronda a doppia parete G2 **GROND PLAST**

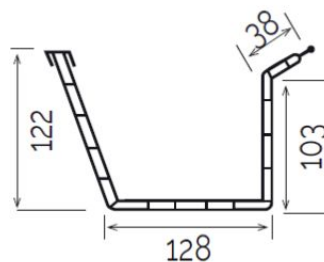
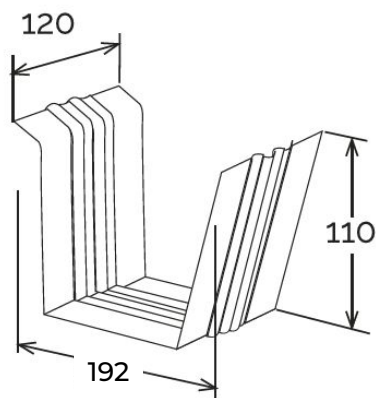
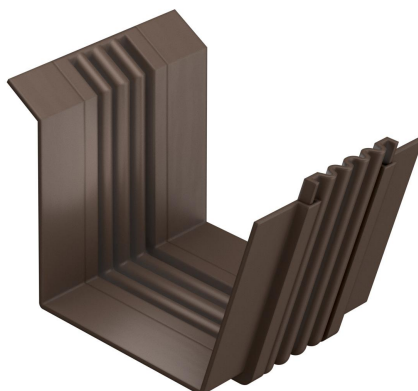

Sezione GRG2

Codice	Colore	lunghezza mm	larghezza mm	altezza mm	Canale gronda abbinabile
<b>GAG2</b>	marrone	192	120	110	GRG240

**Materiale:** PVC-U

**Caratteristiche:** Il giunto va incollato al canale di gronda inserendo questo all'estremità. Utilizzare colla saldante per PVC (COFxxx), previa pulizia delle superfici.

